

描述 / Descriptions

TO-220 塑封封装电压调整器。Voltage Regulator in a TO-220 Plastic Package.

特征 / Features

三端稳压调整器，输出电流高达 1A,内设过热保护和短路限制。

3-Terminal regulators ,output current up to 1A, internal thermal overload protection and short-circuit limiting.

用途 / Applications

电压调整器。

Voltage Regulator.

内部等效电路/应用电路 / Equivalent Circuit or Application Circuit

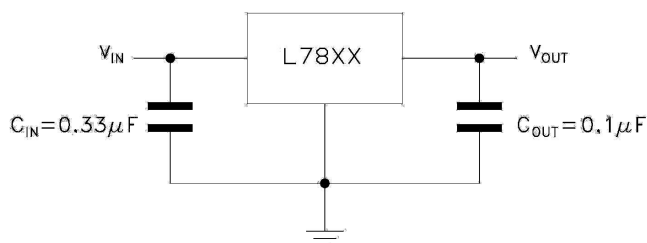

引脚排列 / Pinning

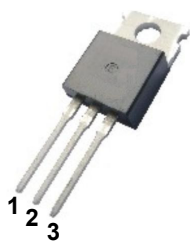

PIN 1 : IN PIN 2 : GND PIN 3 : OUT

印章代码 / Marking

见印章说明。See Marking Instructions.

极限参数 / Absolute Maximum Ratings(Ta=25°C)

参数 Parameter	符号 Symbol	数值 Rating	单位 Unit
Input voltage	V _i	35	V
Operating Junction Temperature Range	T _{OPR}	0~125	°C
Storage temperature range	T _{stg}	-65~150	°C

电性能参数 / Electrical Characteristics(Ta=25°C ,Vi=10V,Io=500mA , unless otherwise specified)

参数 Parameter	符号 Symbol	测试条件 Test Conditions	最小值 Min	典型值 Typ	最大值 Max	单位 Unit
Output voltage	V _o	T _j =25°C	4.8	5.0	5.2	V
		V _i =7V-20V, I _o =5mA-1A Po≤15W	4.75	5.0	5.25	V
Load Regulation	ΔV _o	T _j =25°C I _o =5mA-1.5A			100	mV
		T _j =25°C I _o =250mA-750mA			50	mV
Line regulation	ΔV _o	T _j =25°C V _i =7V-25V		3.0	100	mV
		T _j =25°C V _i =8V-12V		1.0	50	mV
Quiescent Current	I _d	T _j =25°C			8.0	mA
Quiescent Current Change	ΔI _d	V _i =7V-25V			0.8	mA
		I _o =5mA-1A			1.3	mA
Output Voltage Drift	ΔV _o /ΔT	I _o =5mA		-1.1		mV/°C
Output Noise Voltage	e _N	B=10Hz-100KHz T _j =25°C			40	μV/V _o
Supply Voltage Rejection	SVR	V _i =8V-18V f=120Hz	62			dB
Dropout Voltage	V _d	I _o =1A T _j =25°C		2.0		V
Output Resistance	R _o	f=1KHz		17		mΩ
Short Circuit Current	I _{sc}	V _i =35V T _j =25°C		0.75		A
Short Circuit Peak Current	I _{scp}	T _j =25°C		2.2		A

电参数曲线图 / Electrical Characteristic Curve

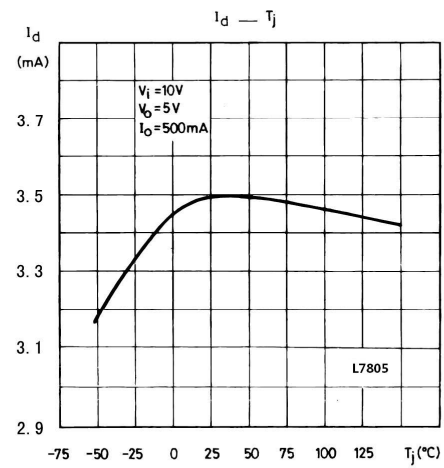
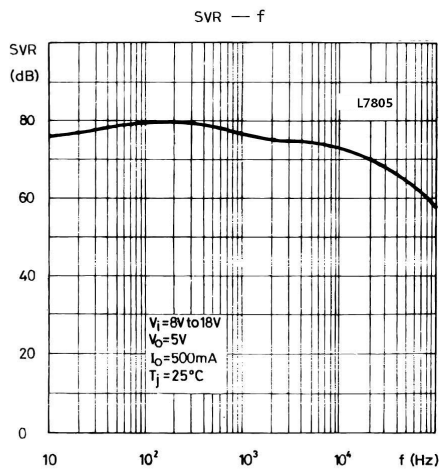
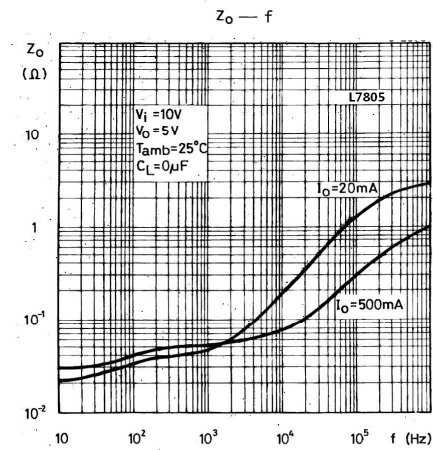
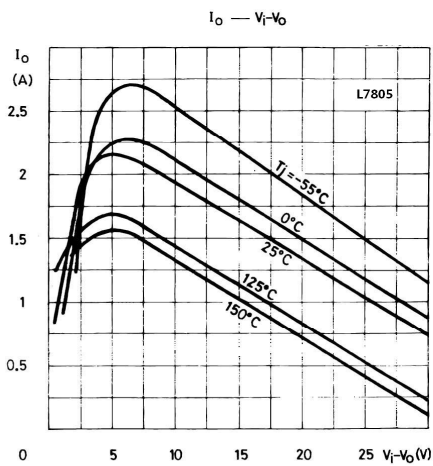
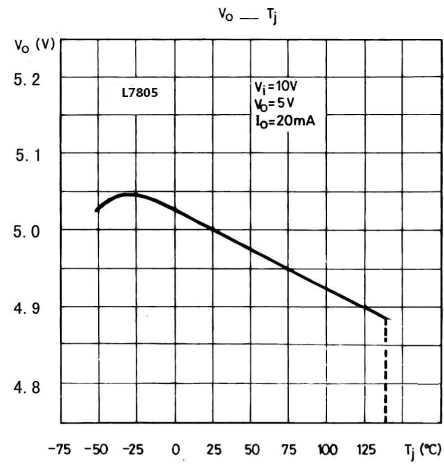
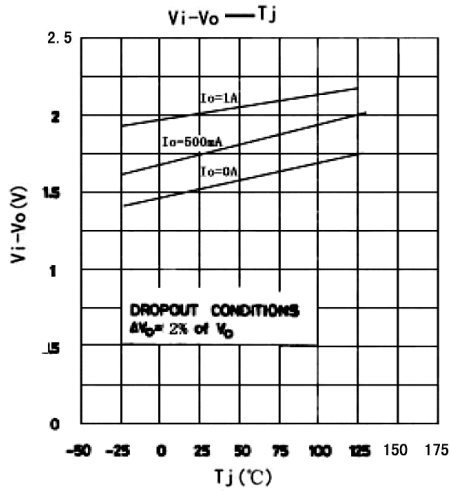

外形尺寸图 / Package Dimensions

TO-220

单位: mm

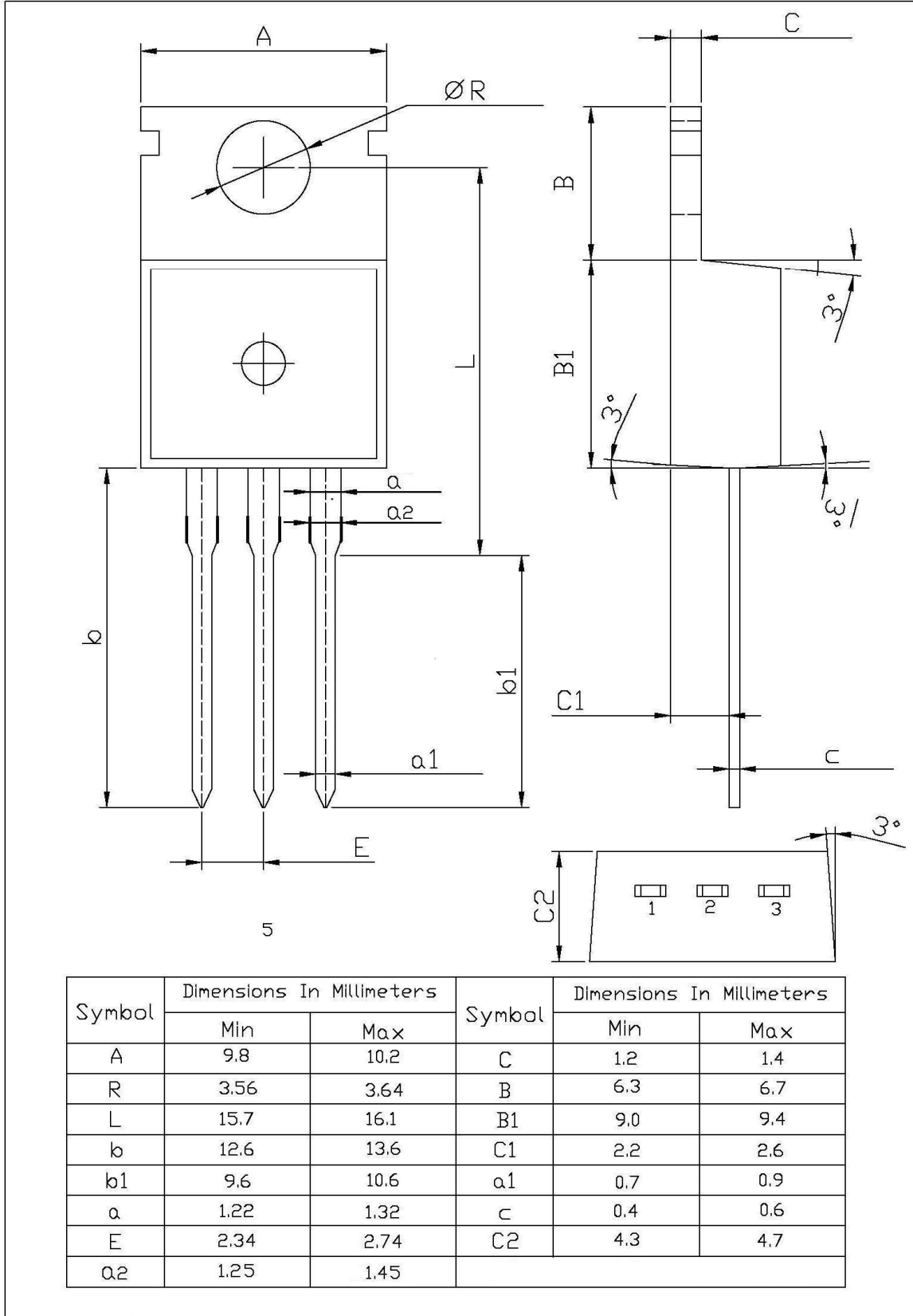

印章说明 / Marking Instructions

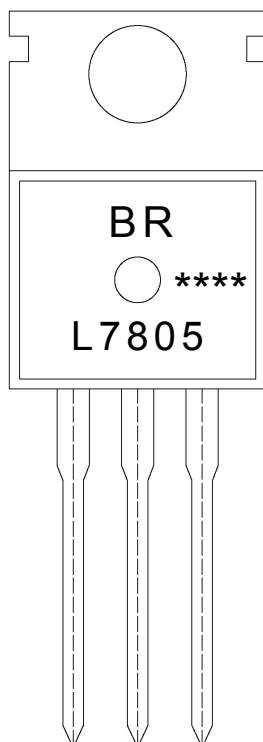

说明：

BR： 为公司代码

L7805： 为产品型号

****： 为生产批号代码，随生产批号变化。

Note:

BR: Company Code.

L7805: Product Type.

****: Lot No. Code, code change with Lot No.

波峰焊温度曲线图(无铅) / Temperature Profile for Dip Soldering(Pb-Free)

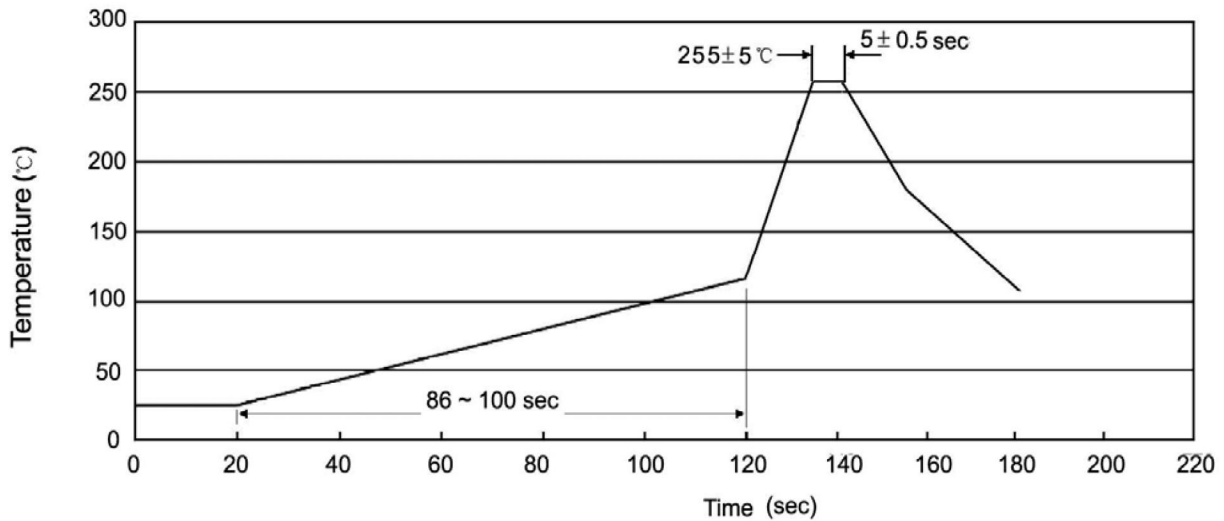

说明：

- 1、预热温度 25~150°C，时间 60~90sec;
- 2、峰值温度 255±5°C，时间持续为 5±0.5sec;
- 3、焊接制程冷却速度为 2~10°C/sec.

Note:

- 1.Preheating:25~150°C, Time:60~90sec.
- 2.Peak Temp.:255±5°C, Duration:5±0.5sec.
3. Cooling Speed: 2~10°C/sec.

耐焊接热试验条件 / Resistance to Soldering Heat Test Conditions

温度：270±5°C 时间：10±1 sec. Temp:270±5°C Time:10±1 sec

包装规格 / Packaging SPEC.

散件包装 / BULK

Package Type 封装形式	Units 包装数量					Dimension 包装尺寸 (unit: mm3)		
	Units/Bag 只/袋	Bags/Inner Box 袋/盒	Units/Inner Box 只/盒	Inner Boxes/Outer Box 盒/箱	Units/Outer Box 只/箱	Bag 袋	Inner Box 盒	Outer Box 箱
TO-220/F	200	10	2,000	5	10,000	135×190	237×172×102	560×245×195

套管包装 / TUBE

Package Type 封装形式	Units 包装数量					Dimension 包装尺寸 (unit: mm3)		
	Units/Tube 只/套管	Tubes/Inner Box 套管/盒	Units/Inner Box 只/盒	Inner Boxes/Outer Box 盒/箱	Units/Outer Box 只/箱	Tube 套管	Inner Box 盒	Outer Box 箱
TO-220/F	50	20	1,000	5	5,000	532×31.4×5.5	555×164×50	575×290×180

使用说明 / Notices